



PART NAME

EXTRUDED ALUMINUM IP65 PCB ENCLOSURES

PART No.

EXN-23359 (SEE TABULATION FOR COMBINATIONS)

REVISION DATE

10-23-15

PART NUMBER	ALUM. COVER	PLASTIC COVER	BODY COLOR
EXN-23359-BK	BLACK	-	BLACK
EXN-23359-BKP	-	BLACK	BLACK
EXN-23359-BL	BLACK	-	BLUE
EXN-23359-BLP	-	TRANSLUCENT BLUE	BLUE
EXN-23359-GD	BLACK	-	GOLD
EXN-23359-GDP	-	CLEAR	GOLD
EXN-23359-RD	BLACK	-	RED
EXN-23359-RDP	-	IR RED	RED
EXN-23359-SV	BLACK	-	SILVER
EXN-23359-SVP	-	CLEAR	SILVER

MATERIAL: ALUMINUM EXTRUSION BODY PROVIDED WITH ALUMINUM COVER (2X) AND GASKETS OR POLYCARBONATE COVER (2X) AND GASKETS - NOT ASSEMBLED

DIMENSIONS ARE INCH[MM]

DRAWING FOR REFERENCE
WE RESERVE THE RIGHT TO MAKE CHANGES TO OUR STANDARD PRODUCTS. PLEASE CONSULT WITH BUD INDUSTRIES PRIOR TO USING THIS DRAWING FOR DESIGN PURPOSE.

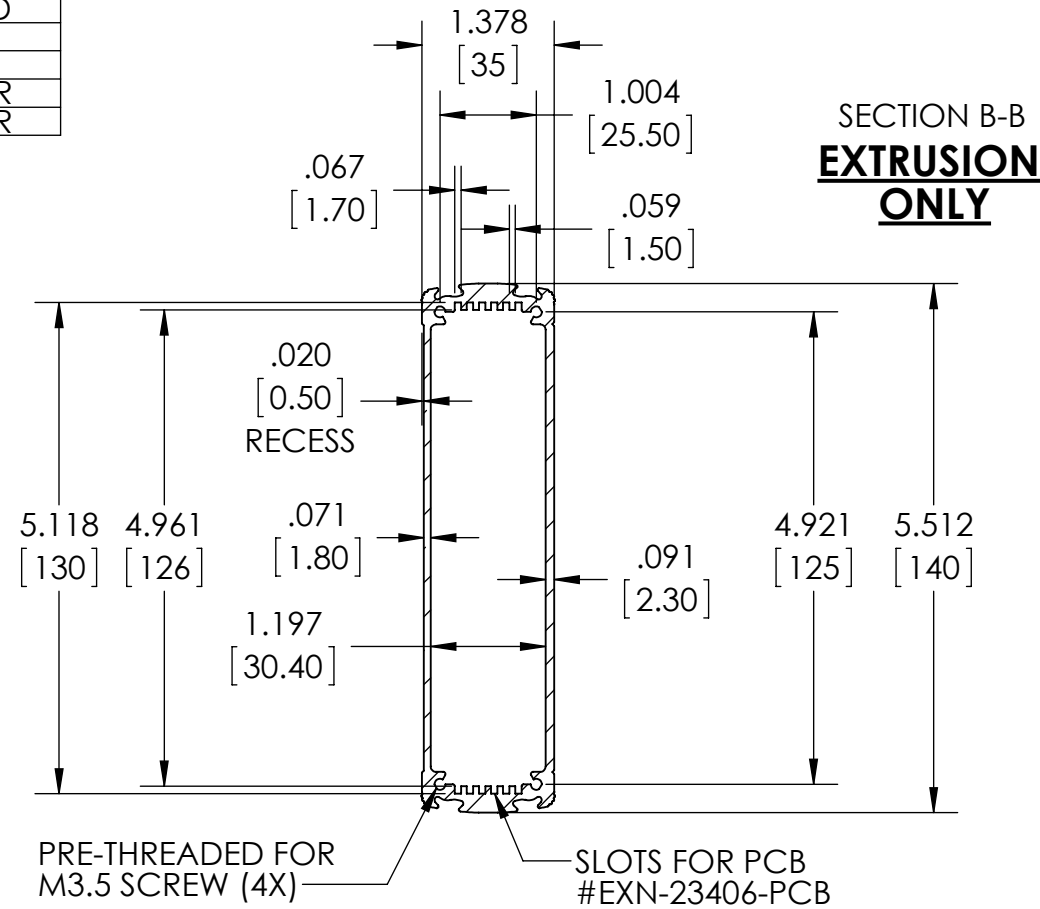
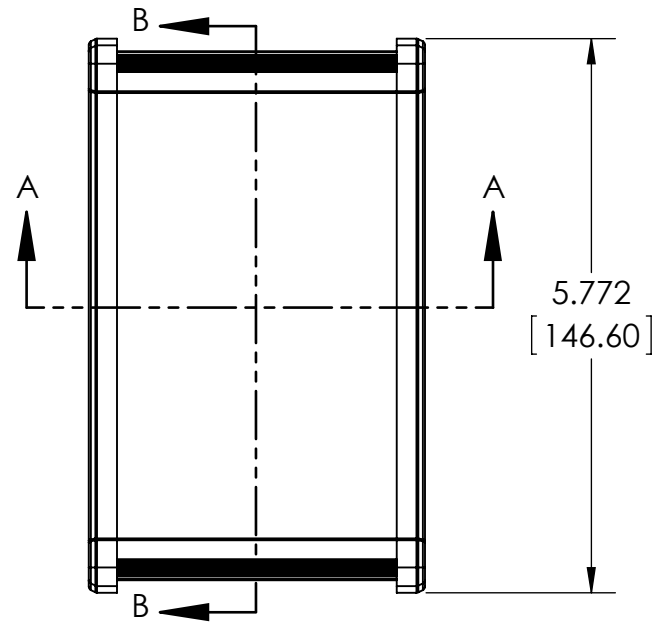

DIE CAST ALUMINUM COVER

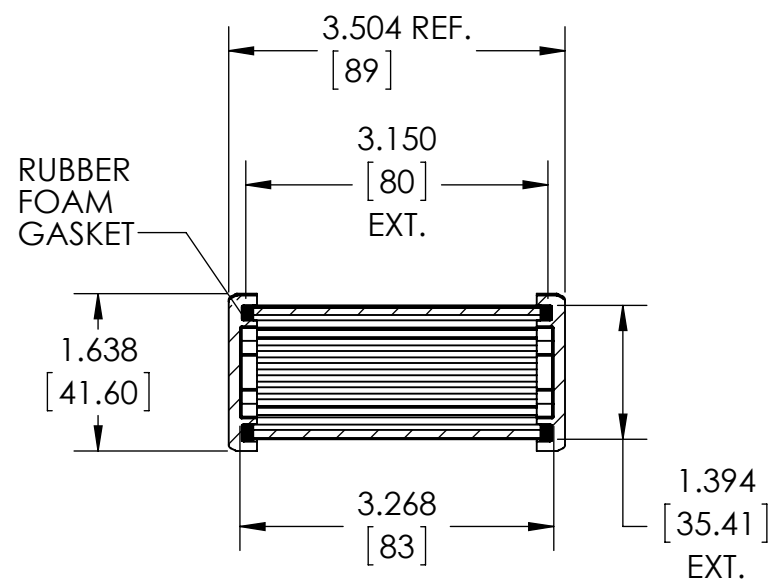
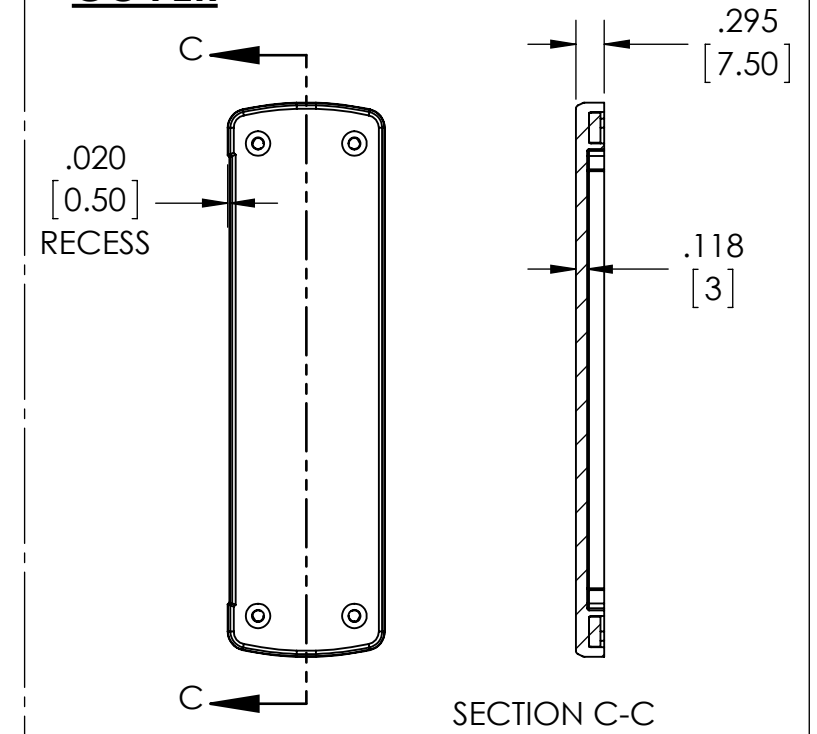
SECTION A-A
SCALE 1 : 2

DIMENSIONS MAY VARY DEPENDING ON THE COMPRESSION OF THE GASKETS

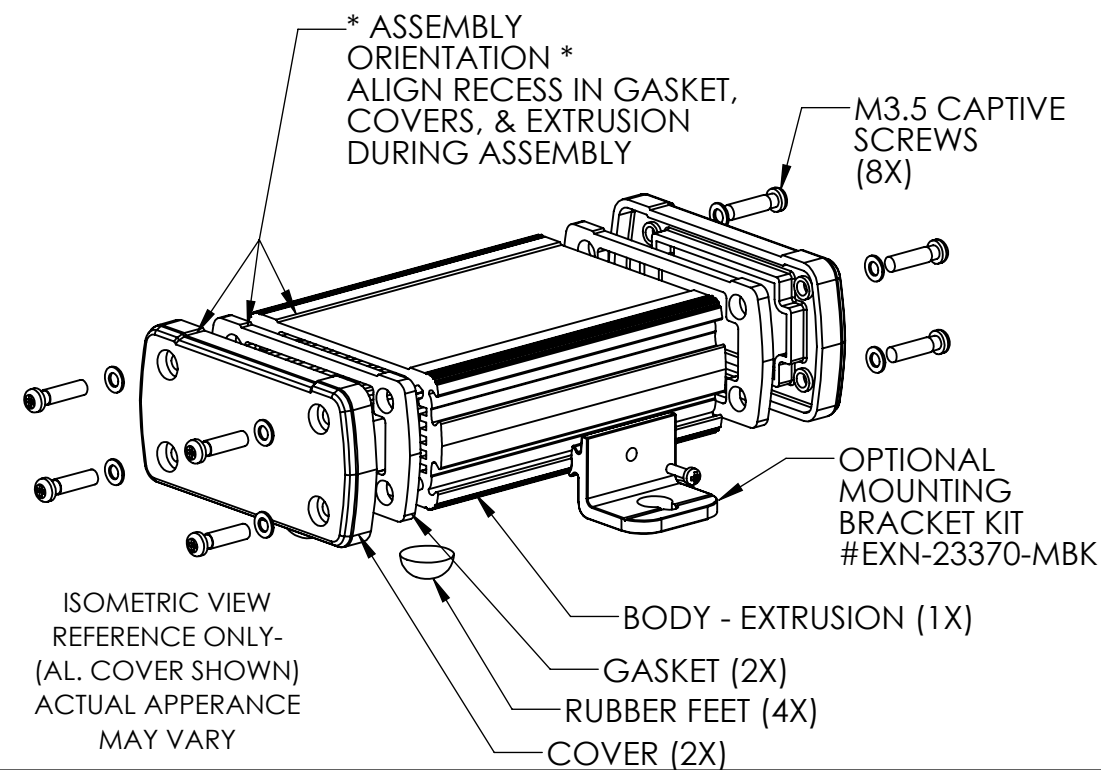

PLASTIC COVER

