



PART NAME

STEEL INTERNAL PANEL

PART No.

PTX-25323

REV. DATE

6-20-19

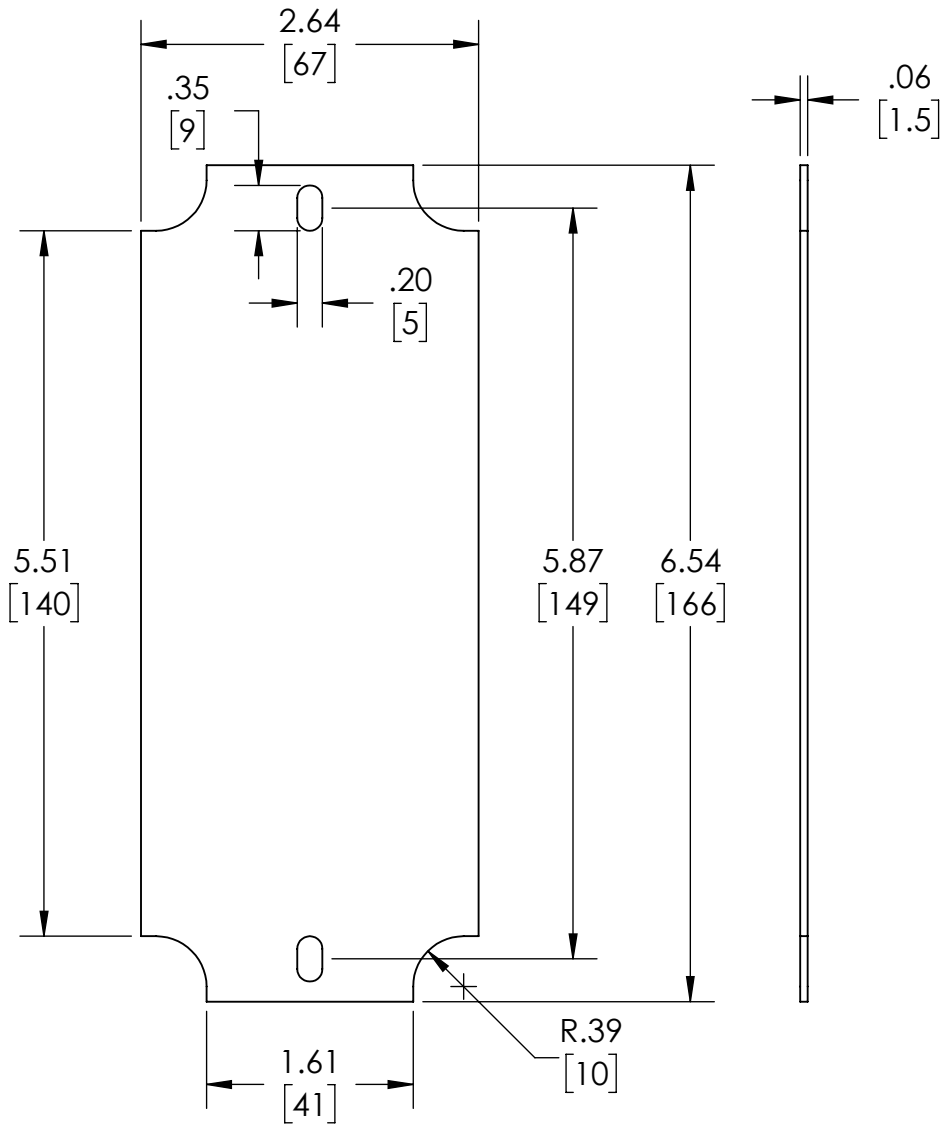

DRAWING FOR REFERENCE

WE RESERVE THE RIGHT TO MAKE CHANGES TO OUR STANDARD PRODUCTS. PLEASE CONSULT WITH BUD INDUSTRIES PRIOR TO USING THIS DRAWING FOR DESIGN PURPOSE.

MATERIAL: 16 GA. [1.5mm] C.R.S.

FINISH: ZINC PLATED

DIMENSIONS ARE INCH [MM]

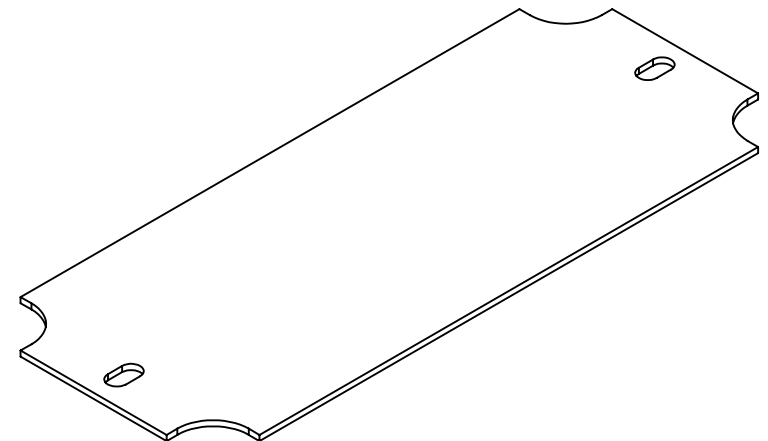

PANEL FITS ENCLOSURE: #PTS-25323 & #PTS-25323-C
(MOUNTING HARDWARE SUPPLIED WITH ENCLOSURE)