

PART NAME

DPH SERIES ENCLOSURE

PART No.

DPH-28729 & DPH-28729-C

REVISION DATE

4/4/23

NOTES:

- MATERIAL AND FLAMMABILITY RATING.
 BODY - PC LIGHT GRAY POLYCARBONATE - UL94-5VA
 COVER - PC LIGHT GRAY POLYCARBONATE - UL94-5VA
 CLEAR COVER (C) - PC CLEAR POLYCARBONATE - UL94-V0 AND TESED TO PASS 5VA PER UL746C
- FOLLOW ENCLOSED INSTRUCTION FOR UL COMPLIANCE.: BOXES UL LISTED NEMA TYPE 1, 2, 3, 3R, 4, 4X, 5, 6, 6P 12, 13. DESIGNED MEETS IP65, IP66, IP67, IP68 REQUIREMENTS. UV RESISTANT FOR OUT DOOR USE.
- OPERATING TEMPERATURE IS -35 TO 110C.
- PRE INSTALLED SILICONE GASKET IN COVER
- BOX COMES WITH 4 UNINSTALLED MOUNTING BRACKETS AND HARDWARE (DPX-100)
- OPTIONAL ACCESSORIES:
 - HINGE AND PANEL SUPPENSION KIT (DPX-444KIT)
 - 12" FLANGE KIT (2 FLANGES + 4 SCREWS) (DPX-1224KIT)
 - FLOATING INTERNAL MOUNTING PANEL (DPX-287294)
 - HINGED INTERNAL MOUNTING PANEL (DPX-287292)
 - COVER MOUNTING PANEL (DPX-287293)
 - BASE INTERNAL MOUNTING PANEL (DPX-287291)
- DIMENSIONS ARE IN INCH

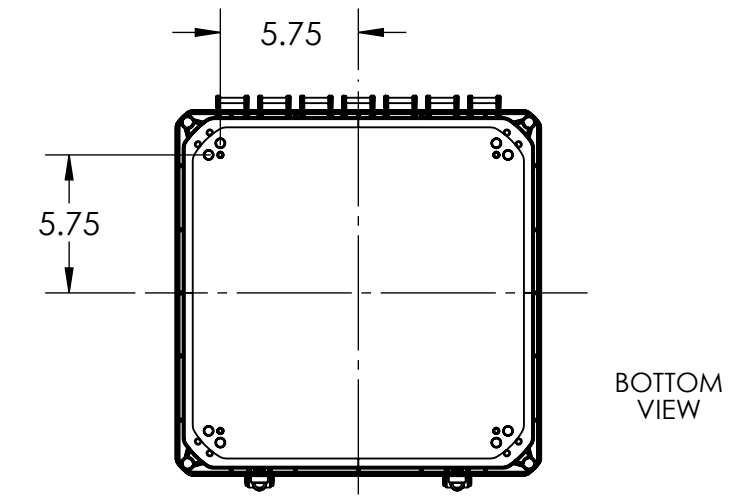
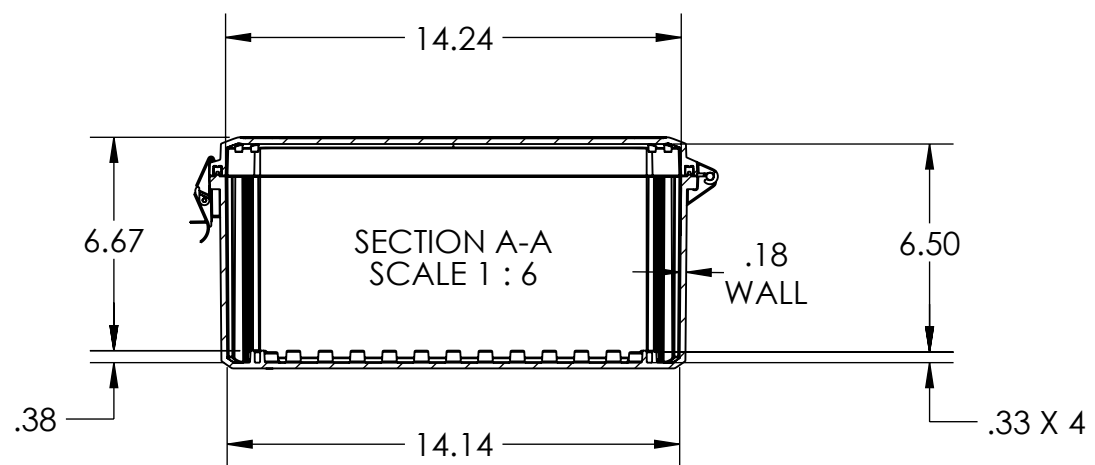
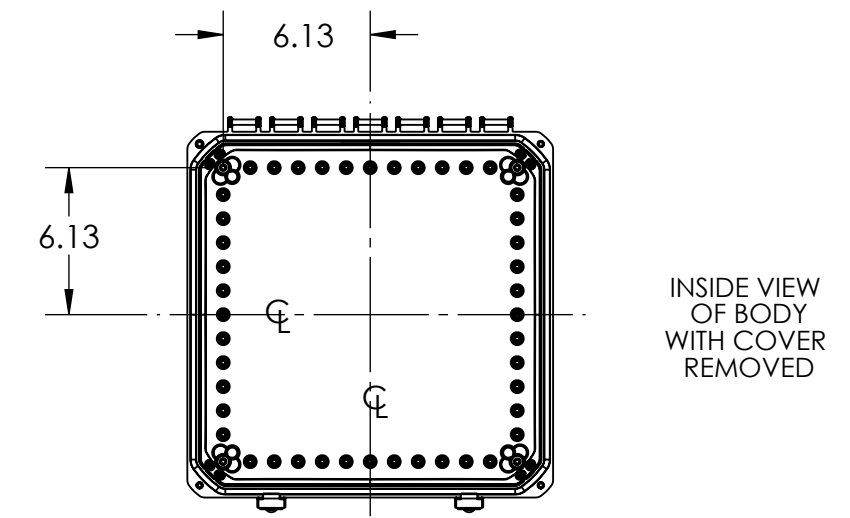
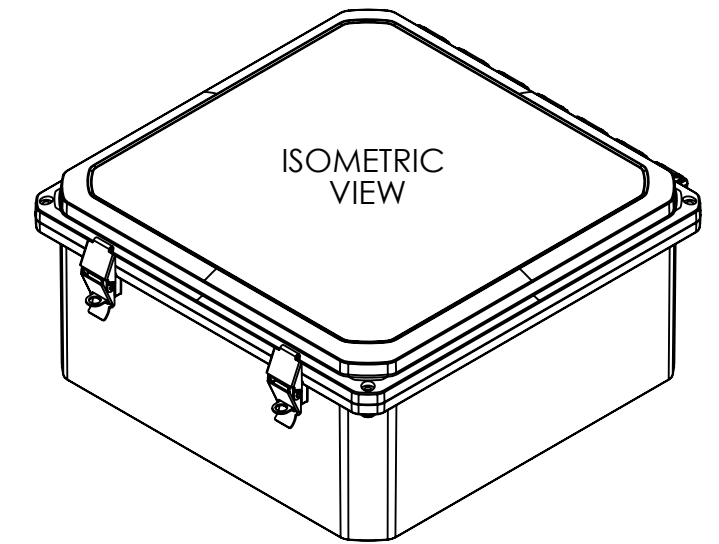
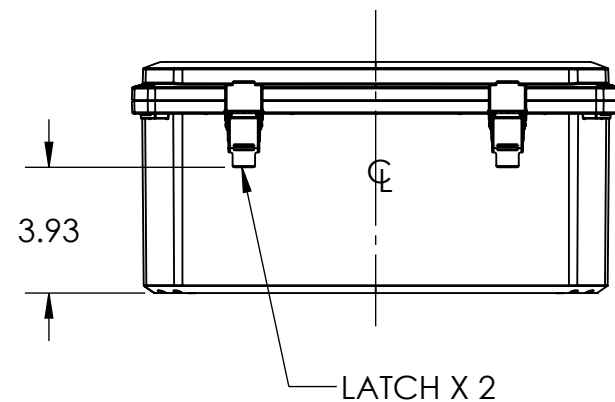
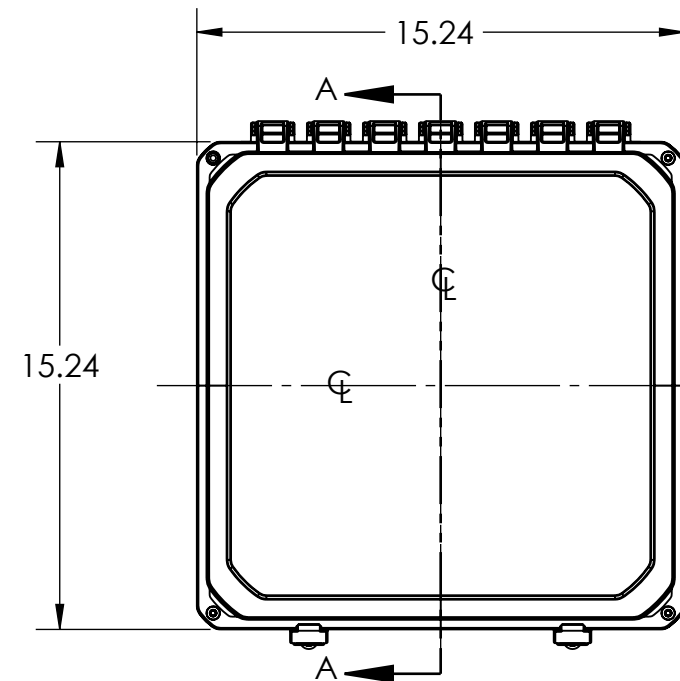
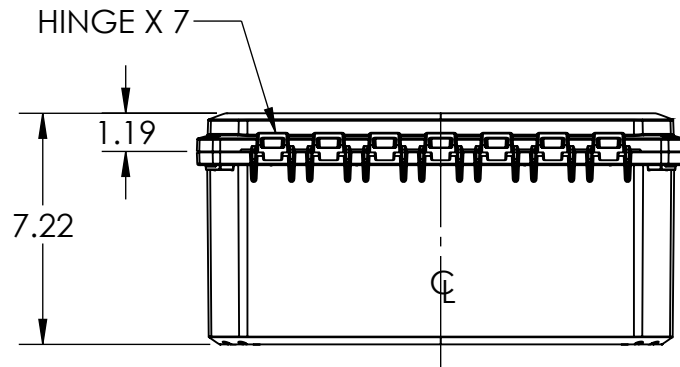

DRAWING FOR REFERENCE
 WE RESERVE THE RIGHT TO MAKE CHANGES TO OUR STANDARD PRODUCTS. PLEASE CONSULT WITH BUD INDUSTRIES PRIOR TO USING THIS DRAWING FOR DESIGN PURPOSE.