

NOTES:

1. MATERIAL: ABS
2. FINISH: BODY/COVER - GRAY
3. RoHS COMPLIANT
4. CONTINUOUS GASKET IN COVER
5. -20°C TO +65°C EXTENDED EXPOSURE CONDITION
6. SUPPLIED WITH TWO M4 x 8mm LG. TRUSS HEAD MACHINE SCREWS
7. DIMENSIONS ARE INCH [MM]
8. OPTIONAL ACCESSORIES:
 INTERNAL STEEL PANEL - #PTX-22440
 INTERNAL PLASTIC PANEL - #PTX-22440-P
 MOUNTING BRACKET KIT (STAINLESS STEEL) - #NBX-10922

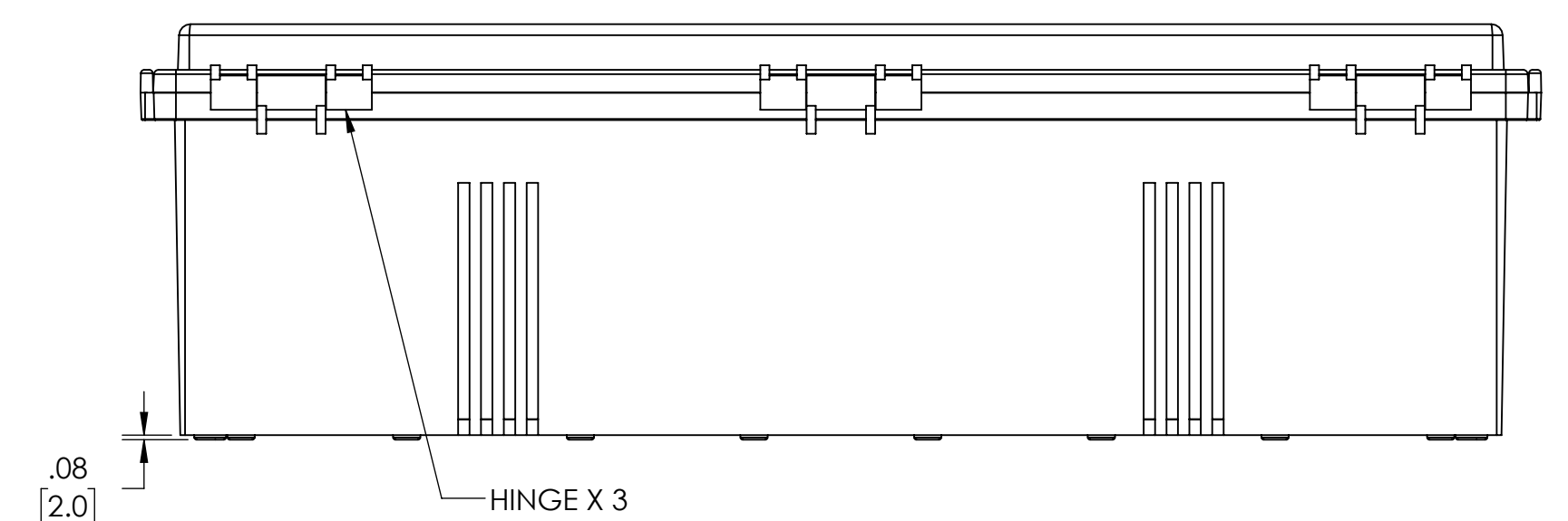
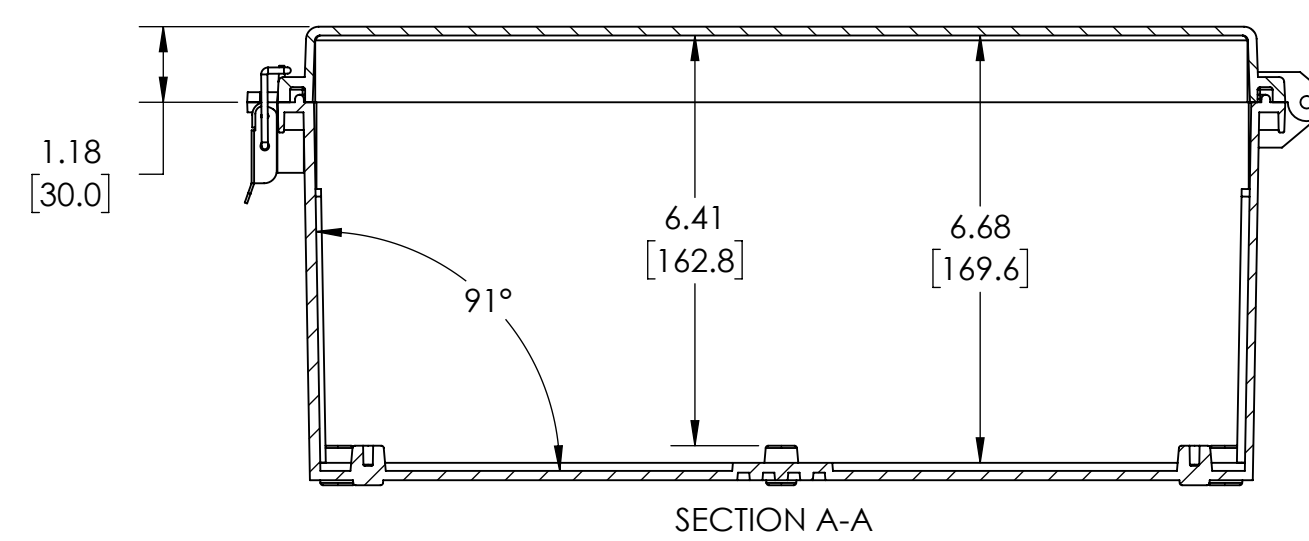
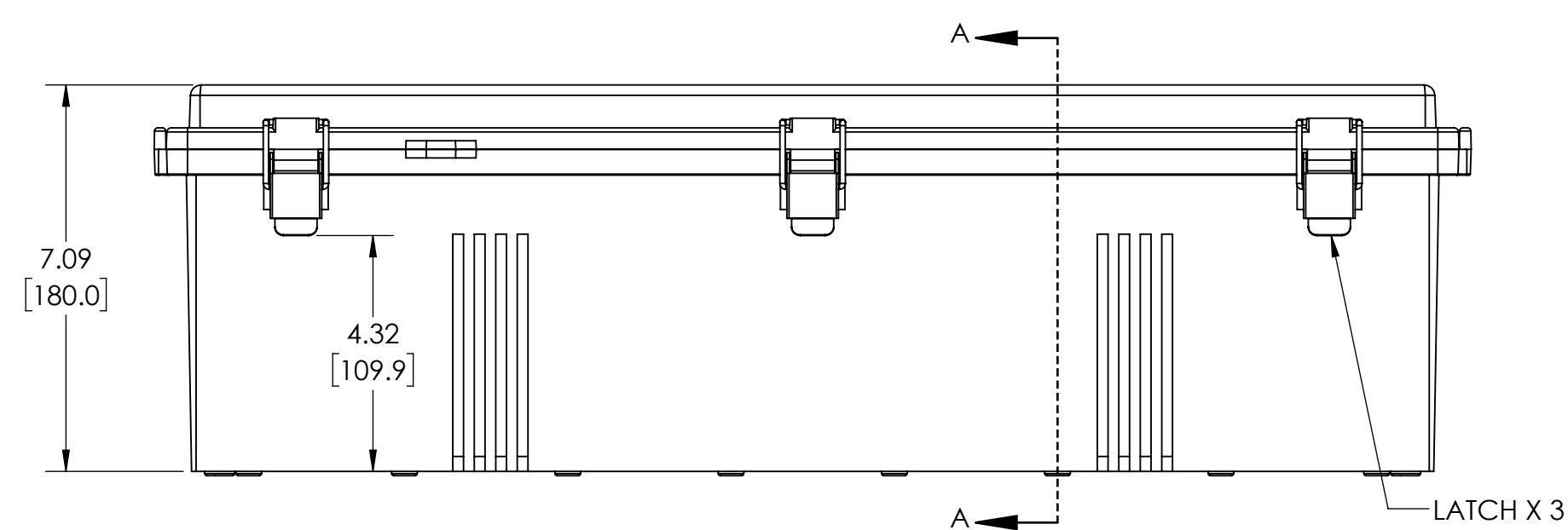
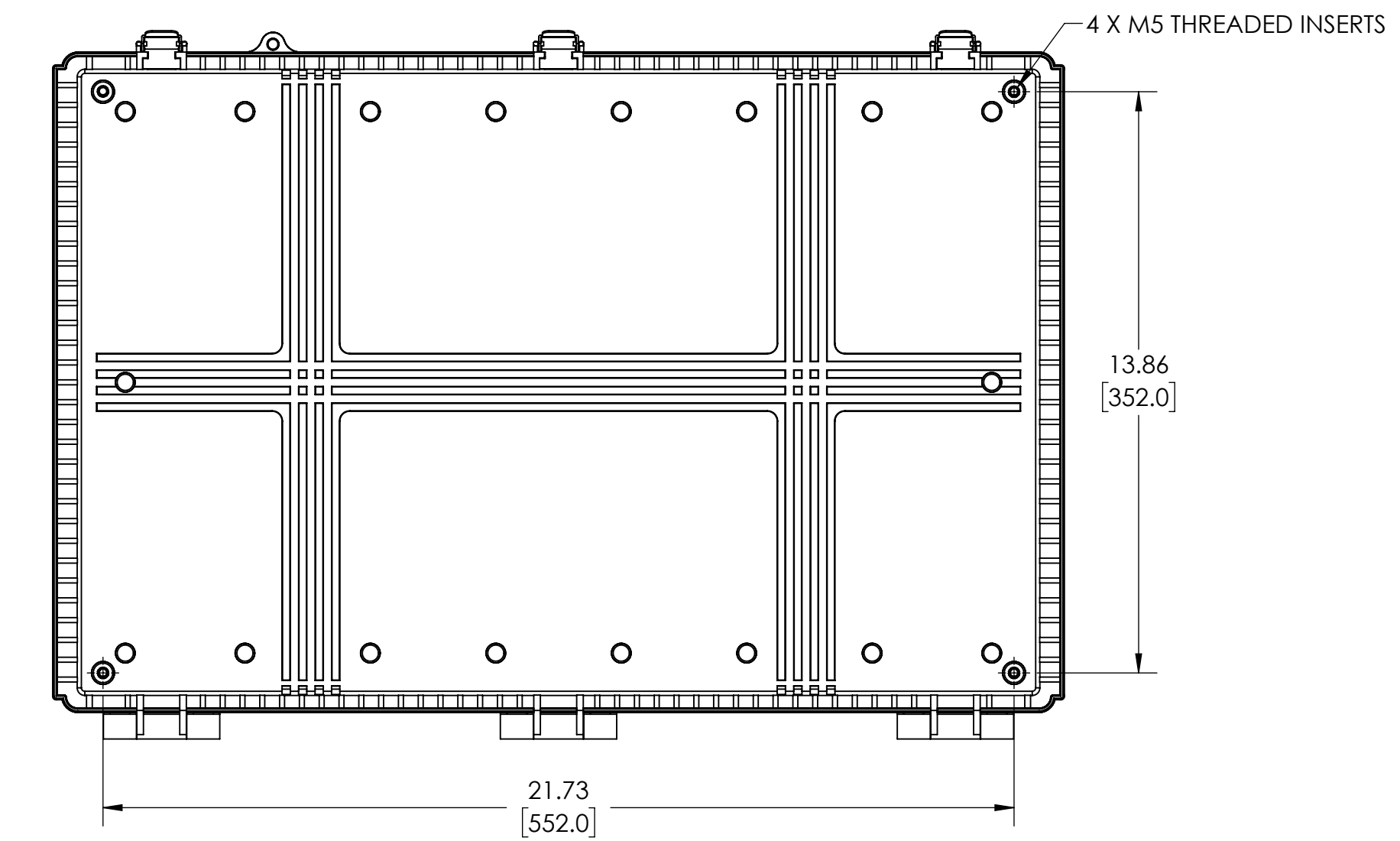
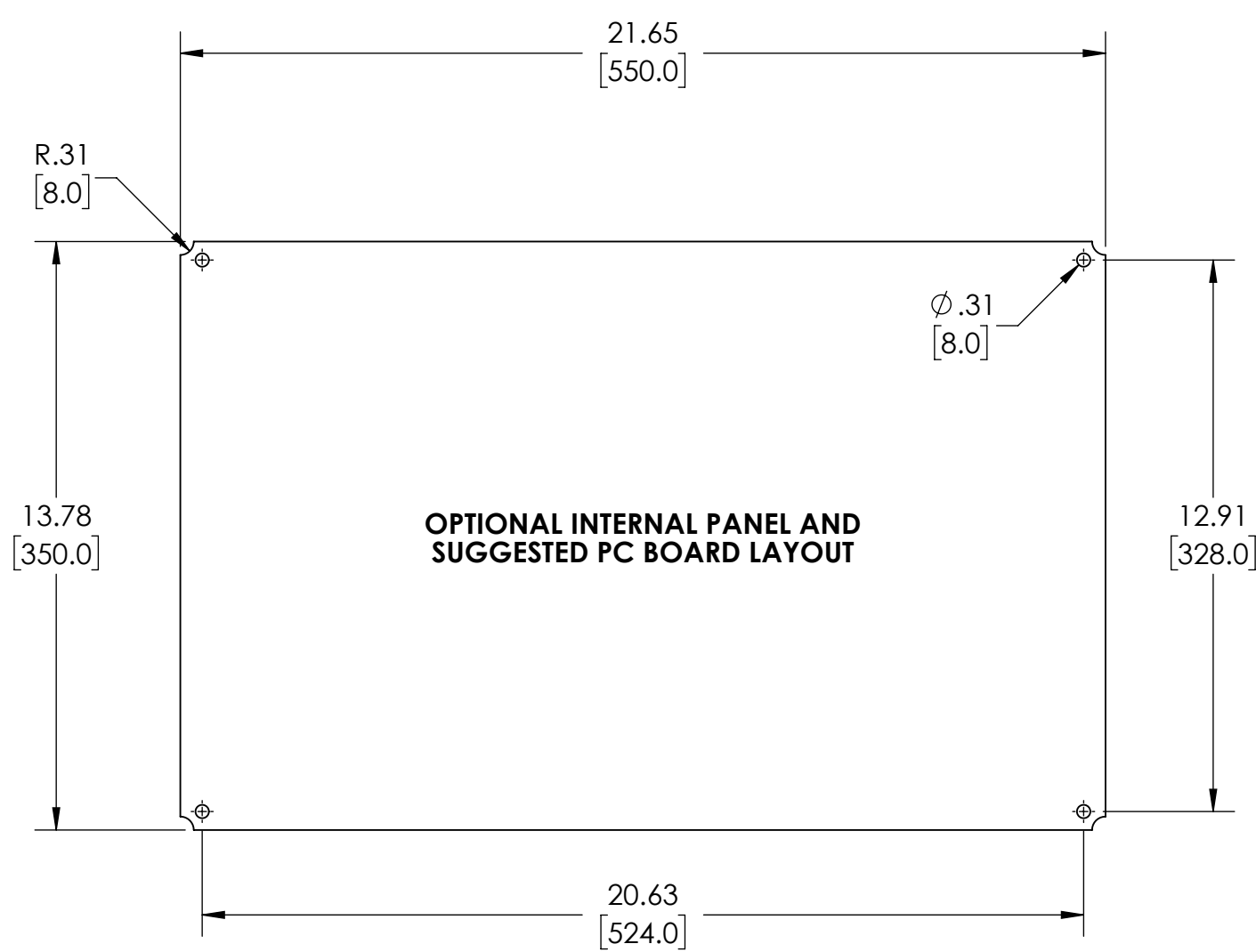
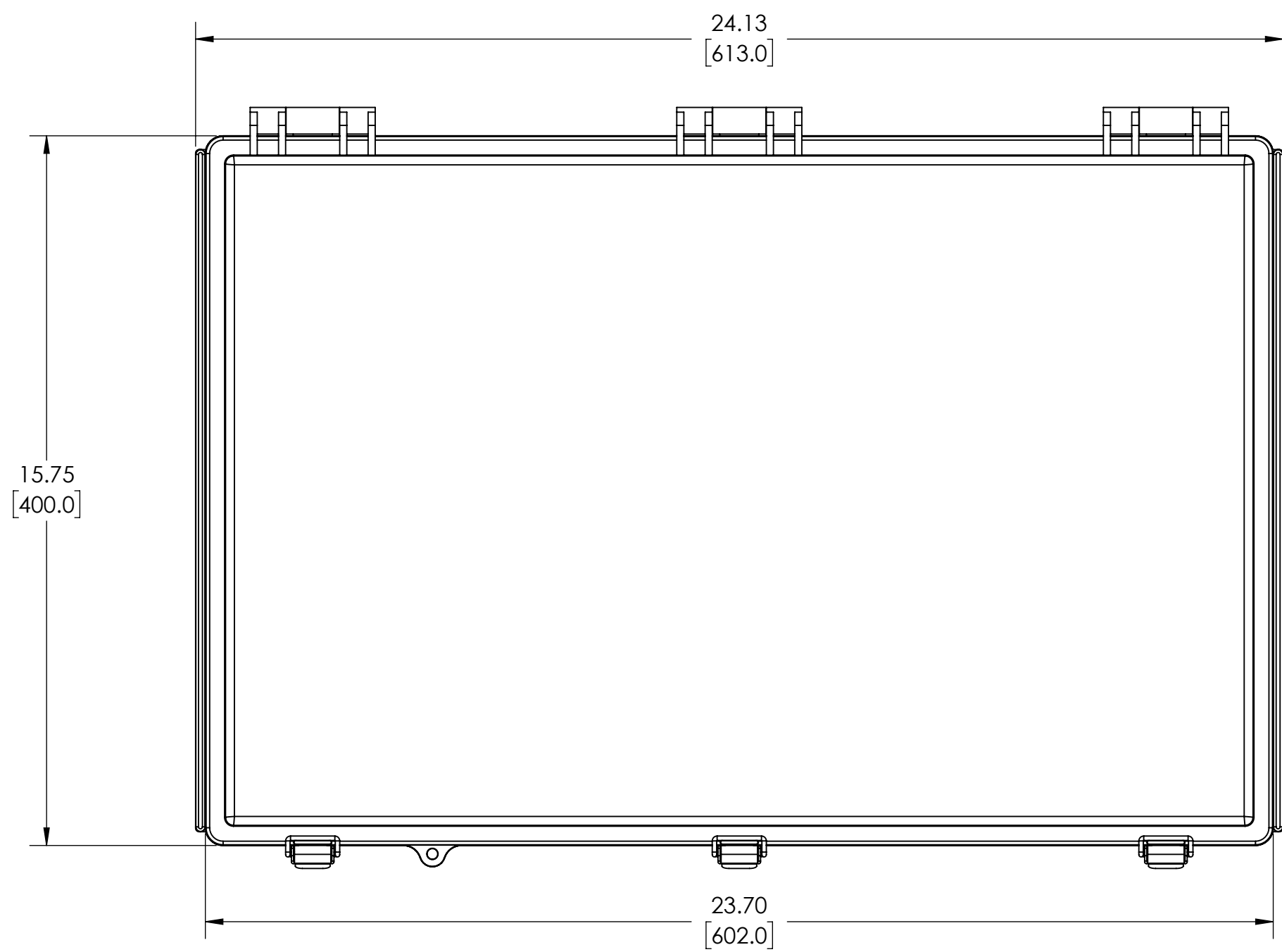
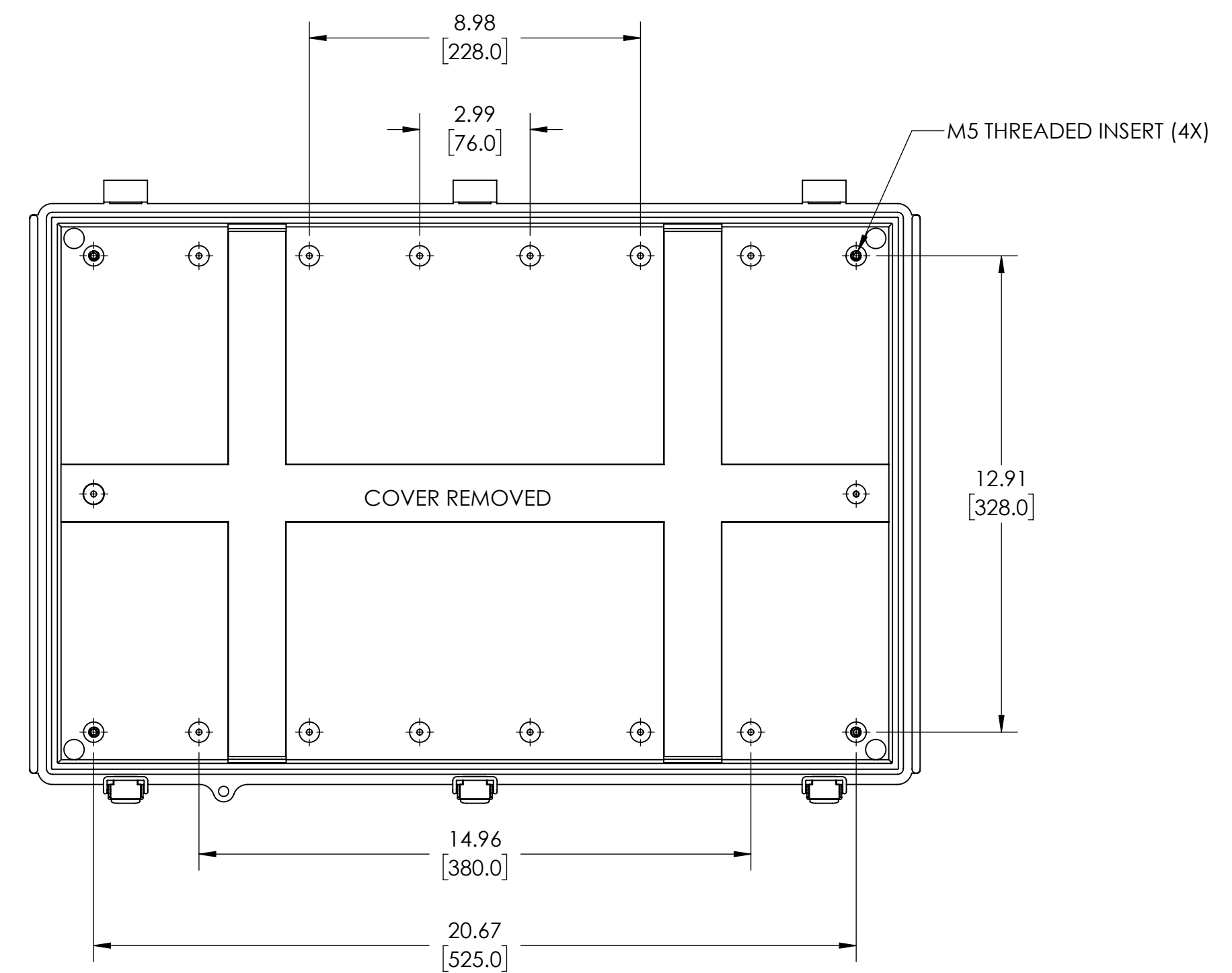

DRAWING FOR REFERENCE
 WE RESERVE THE RIGHT TO MAKE CHANGES TO OUR STANDARD PRODUCTS. PLEASE CONSULT WITH BUD INDUSTRIES PRIOR TO USING THIS DRAWING FOR DESIGN PURPOSE.