

PART
NAME

INTERNAL PANEL

PART
No.

ANX-93829

REV.
DATE

8-28-20

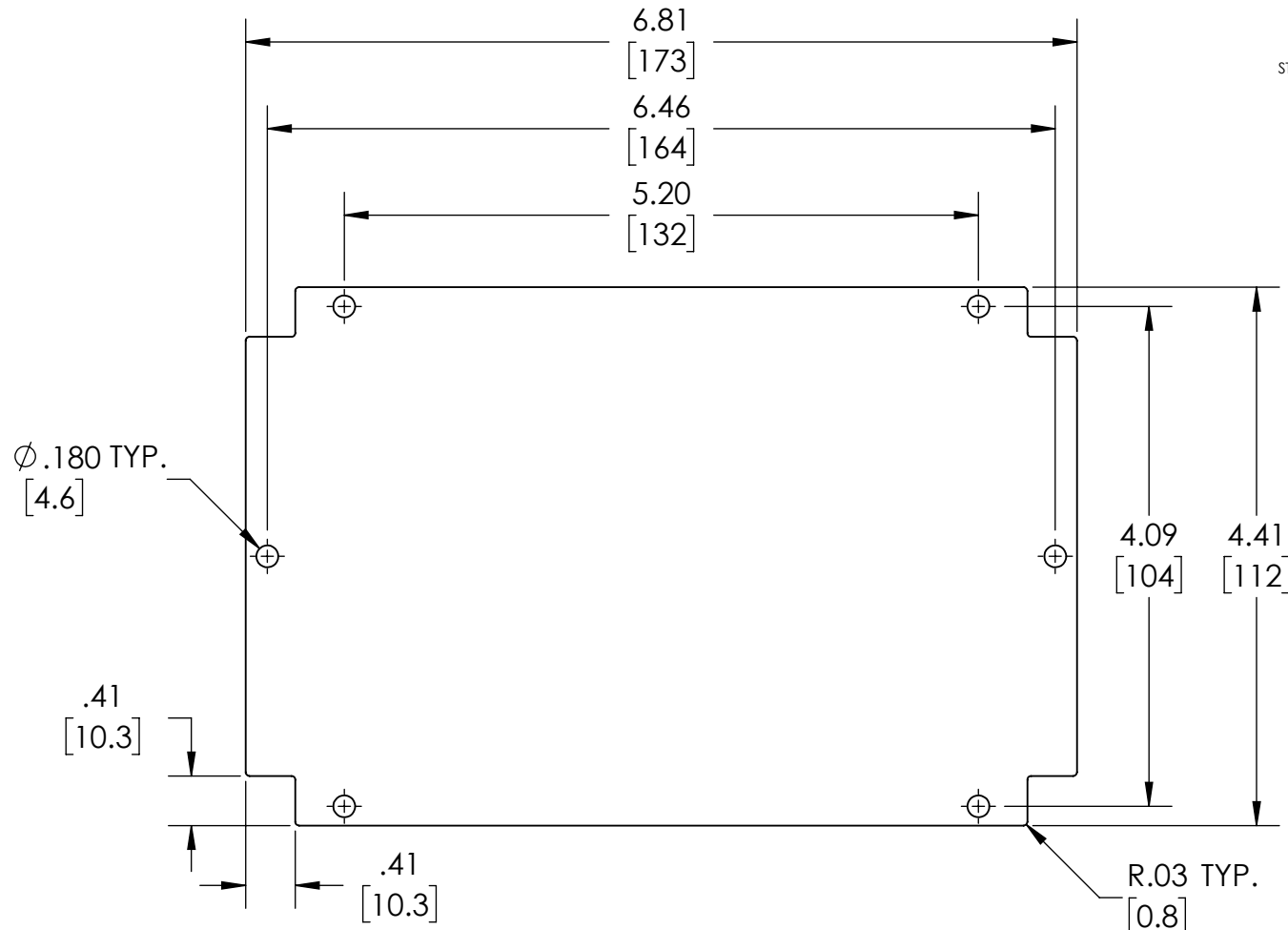

DRAWING FOR REFERENCE
WE RESERVE THE RIGHT TO MAKE CHANGES TO OUR
STANDARD PRODUCTS. PLEASE CONSULT WITH BUD INDUSTRIES
PRIOR TO USING THIS DRAWING FOR DESIGN PURPOSE.

MATERIAL - .060 [1.5mm] THK. ALUMINUM

FINISH - NATURAL

SUPPLIED WITH M3.5 x 6mm LG. SELF-THREADING SCREWS
(PAN HD., PHILLIPS DRIVE, STEEL, ZINC PLATED) FOR
MOUNTING.

PANEL FITS THE FOLLOWING ENCLOSURES:
ANS-3829, ANS-3831, IPS-3929 & IPS-3931

