

DRAWING FOR REFERENCE
 WE RESERVE THE RIGHT TO MAKE CHANGES TO OUR STANDARD PRODUCTS. PLEASE CONSULT WITH BUD INDUSTRIES PRIOR TO USING THIS DRAWING FOR DESIGN PURPOSE.

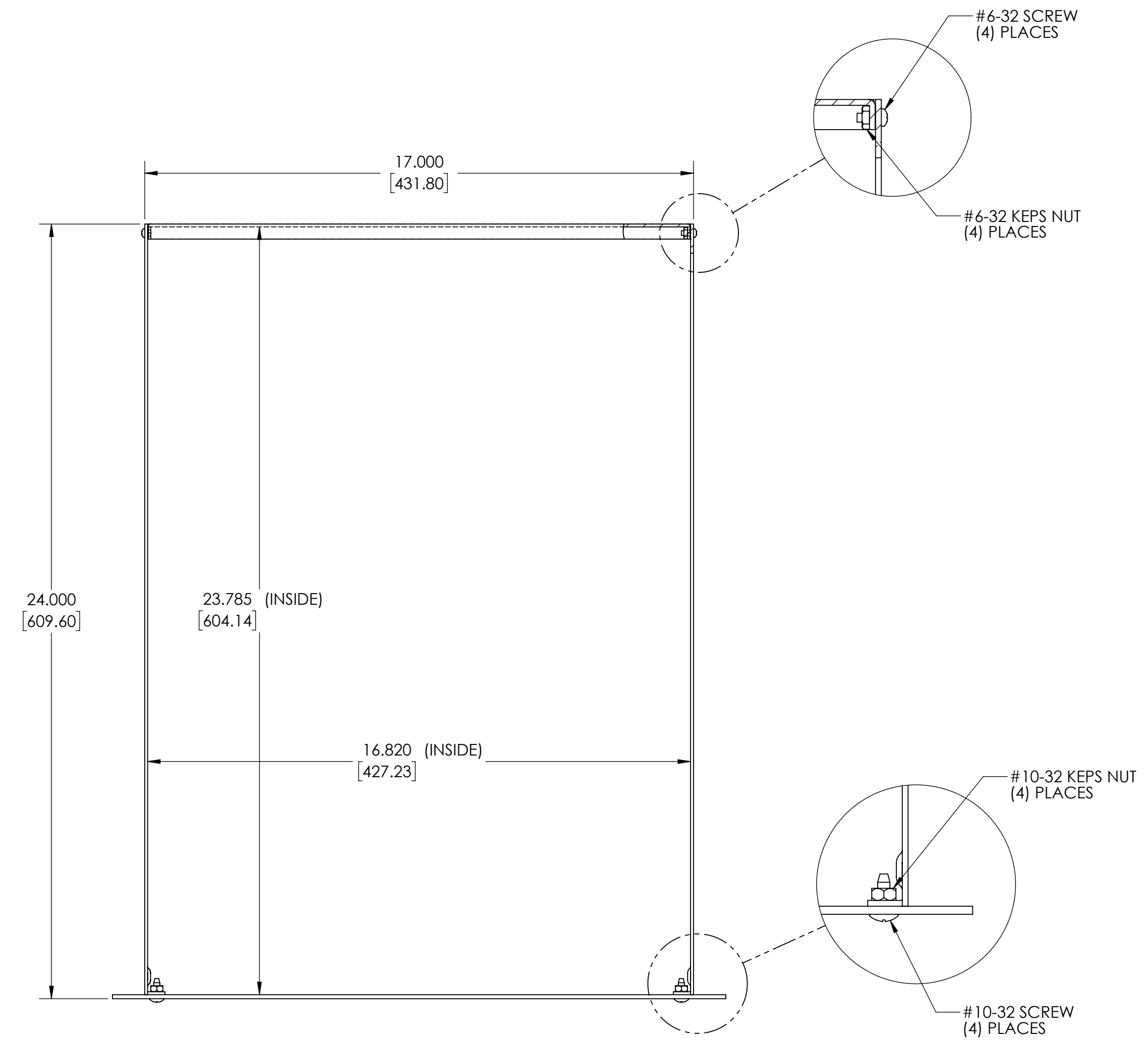

TOP VIEW

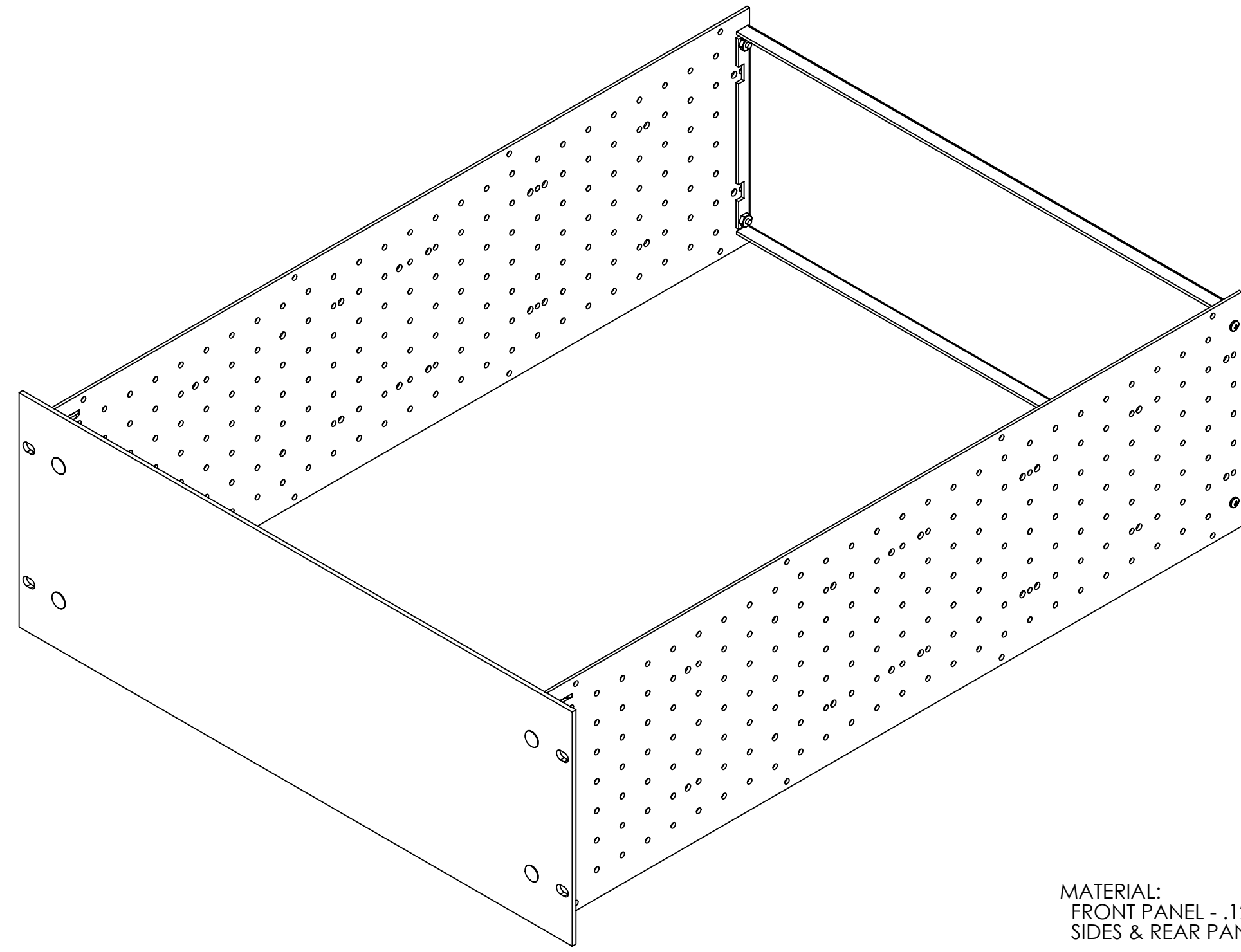

MATERIAL:
 FRONT PANEL - .125 THK. ALUMINUM
 SIDES & REAR PANEL - .090 THK. ALUMINUM

FINISH:
 ALL PARTS - NATURAL

UNIT SHIPPED UNASSEMBLED IN KIT FORM WITH ALL NECESSARY ASSEMBLY HARDWARE
 25 LB. EQUIPMENT LOAD RATING
 50 LB. EQUIPMENT LOAD RATING WHEN USING OPTIONAL REAR MOUNTING BRACKET

OPTIONAL ACCESSORIES:
 INTERNAL CHASSIS - C-14243
 SOLID TOP/BOTTOM COVER - TBC-14254
 VENTILATED TOP/BOTTOM COVER - TBC-14264
 REAR MOUNTING BRACKET - MB-14273
 SLIDES - AS-5002-A OR AS-5004-A
 HANDLES - H-9111-B

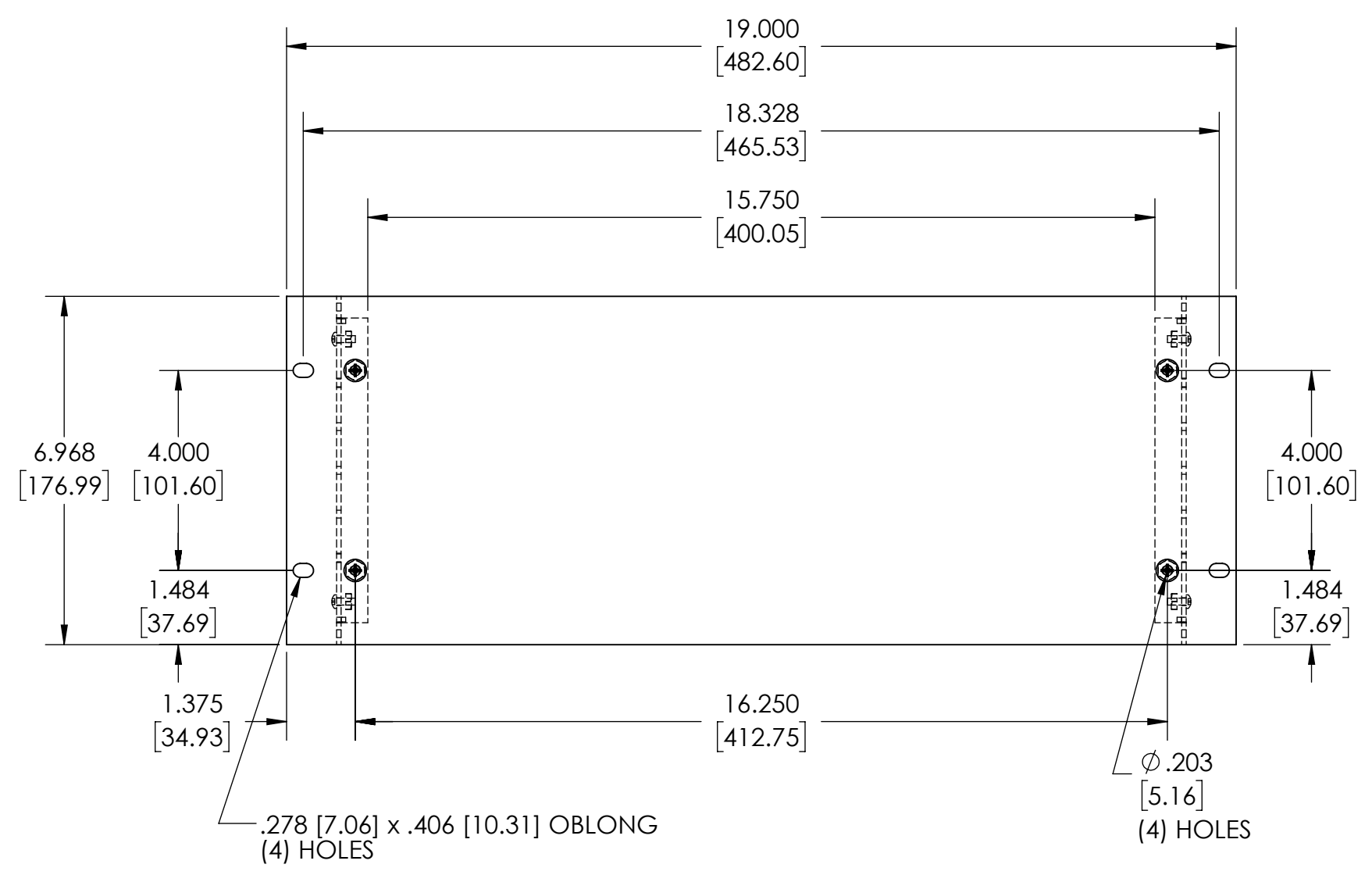

FRONT VIEW

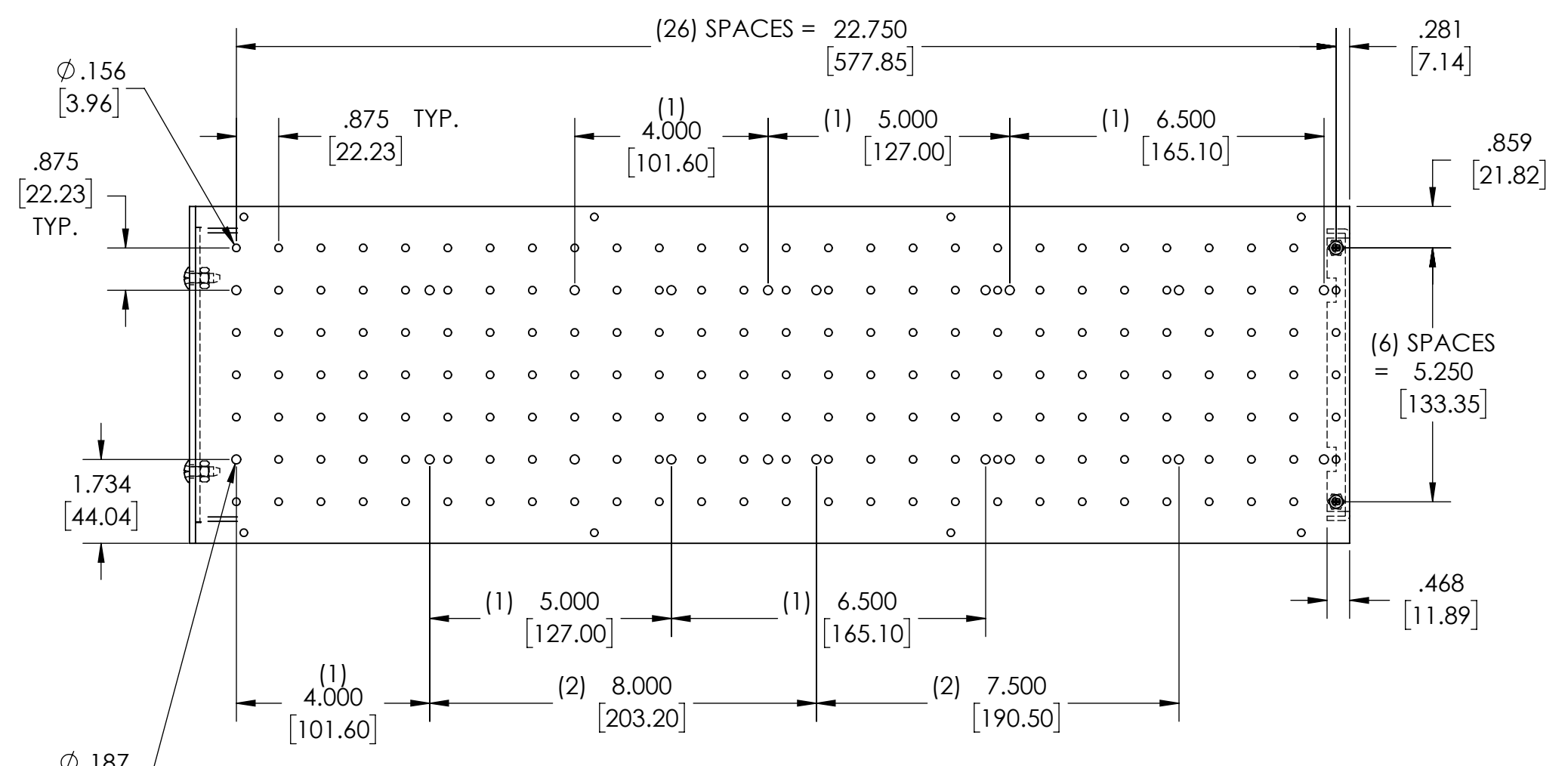

RIGHT SIDE VIEW

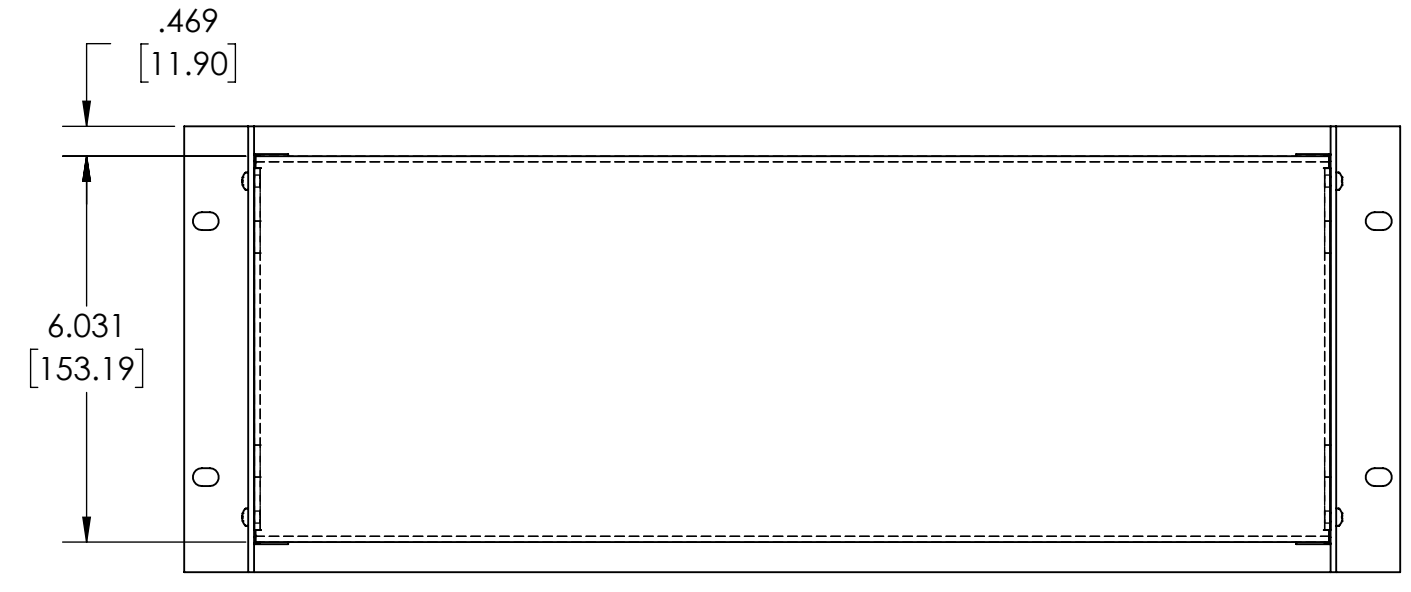

BACK VIEW

NOTE:
 (1) SLIDE MOUNTING LOCATION FOR AS-5002-A
 (2) SLIDE MOUNTING LOCATION FOR AS-5004-A